



Important: Please read.

Disclaimer of liability:

This product is part of an overall concept and may only be used in conjunction with the associated original products according to the instructions and recommendation of Nobel Biocare. Non-recommended use of products made by third parties in conjunction with Nobel Biocare products will void any warranty or other obligation, express or implied, of Nobel Biocare. The user of Nobel Biocare products has the duty to determine whether or not any product is suitable for the particular patient and circumstances. Nobel Biocare disclaims any liability, express or implied, and shall have no responsibility for any direct, indirect, punitive or other damages, arising out of or in connection with any errors in professional judgment or practice in the use of Nobel Biocare products. The user is also obliged to study the latest developments in regard to this Nobel Biocare product and its applications regularly. In cases of doubt, the user has to contact Nobel Biocare. Since the utilization of this product is under the control of the user, they are his/her responsibility. Nobel Biocare does not assume any liability whatsoever for damage arising thereof. Please note that some products detailed in this Instruction for Use may not be regulatory cleared, released or licensed for sale in all markets.

Description:

Implant:

NobelActive® dental implants are made from biocompatible commercially pure grade 4 titanium with TiUnite® surface. The NobelActive® WP implant comes with a co-packed Cover Screw made of titanium alloy Ti-6Al-4V.

Tooling:

Nobel Biocare Twist Drills, Twist Step Drills and Screw Taps are made of stainless steel with DLC (Diamond Like Carbon) coating and should be used in conjunction with NobelActive® implants.

Indications for use:

NobelActive® implants are endosseous implants intended to be surgically placed in the upper or lower jaw bone for anchoring or supporting tooth replacements to restore patient esthetics and chewing function.

NobelActive® 3.0 implants are intended to replace a lateral incisor in the maxilla and/or a central or lateral incisor in the mandible.

NobelActive® implants are indicated for single or multiple unit restorations in splinted or non-splinted applications. This can be achieved by a 2-stage or 1-stage surgical technique in combination with immediate, early or delayed loading protocols, recognizing sufficient primary stability and appropriate occlusal loading for the selected technique.

NobelActive® 3.0 implants are indicated for single unit restorations only.

Contraindications:

It is contraindicated placing NobelActive® in patients:

- who are medically unfit for an oral surgical procedure.
- with inadequate bone volume unless an augmentation procedure can be considered.

- in whom adequate sizes, numbers or desirable positions of implants are not reachable to achieve safe support of functional or eventually parafunctional loads.
- allergic or hypersensitive to commercially pure titanium (grade 4), titanium alloy Ti-6Al-4V (titanium, aluminum, vanadium), stainless steel, or DLC (Diamond Like Carbon) coating.

NobelActive® 3.0 implants are not indicated to replace a central incisor, a canine, a premolar or a molar in the maxilla nor to replace a canine, a premolar or a molar in the mandible.

NobelActive® 3.0 implants are not indicated for multiple tooth replacements.

Warnings:

Failure to recognize actual lengths of drills relative to radiographic measurements can result in permanent injury to nerves or other vital structures. Drilling beyond the depth intended for lower jaw surgery may potentially result in permanent numbness to the lower lip and chin or lead to a hemorrhage in the floor of the mouth.

Beside the mandatory precautions for any surgery such as of asepsis, during drilling in the jaw bone, one must avoid damage the nerves and vessels by referring to anatomical knowledge and preoperative radiographs.

Cautions:

General:

One hundred percent implant success cannot be guaranteed. Failure to observe the indicated limitations of use and working steps may result in failure.

Treatment by means of implants may lead to loss of bone, biologic or mechanical failures including fatigue fracture of implants.

Close cooperation between surgeon, restorative dentist and dental laboratory technician is essential for a successful implant treatment.

It is strongly recommended that NobelActive® implants are used only with dedicated Nobel Biocare surgical instruments and prosthetic components, as combining components that are not dimensioned for correct mating can lead to mechanical instrumental failure, damage to tissue or unsatisfactory esthetic results.

It is strongly recommend that clinicians, new as well as experienced implant users, always go through special training before undertaking a new treatment method. Nobel Biocare offers a wide range of courses for various levels of knowledge and experience. For more information please visit www.nobelbiocare.com.

Working the first time with a colleague, experienced with a new device/ treatment method, will provide further insight and understanding. Nobel Biocare has a global network of mentors available for this purpose.

Before surgery:

Careful clinical and radiological examination of the patient has to be performed prior to surgery to determine the psychological and physical status of the patient.

Special attention has to be given to patients who have local or systemic factors that could interfere with the healing process of either bone or soft tissue or the osseointegration process (e.g., cigarette smoking, poor oral hygiene, uncontrolled diabetes, oro-facial radiotherapy, steroid therapy, infections in the neighboring bone).

Special caution is advised in patients who receive bisphosphonate therapy.

In general, implant placement and prosthetic design must accommodate individual patient conditions. In case of bruxism or unfavorable jaw relationships reappraisal of the treatment option may be considered.

With respect to pediatric patients, routine treatment is not recommended until the end of the jaw bone growth phase has been properly documented.

Pre-operative hard tissue or soft tissue deficits may yield a compromised esthetic result or unfavorable implant angulations.

At surgery:

Particular caution should be used when placing narrow platform implants in the posterior region due to risk of prosthetic overload.

All instruments and tooling used during procedure must be maintained in good condition and care must be taken that instrumentation does not damage implants or other components.

Because of the small sizes of the devices, care must be taken that they are not swallowed or aspirated by the patient.

NobelActive® implants may be tilted up to 45° relative to the occlusal plane. When used with angulations between 30° and 45°, the following applies: The tilted implant must be splinted; a minimum of 4 implants must be used when supporting a fixed prosthesis in a fully edentulous arch.

After the implant installation, the surgeon's evaluation of bone quality and primary stability will determine when implants may be loaded. Lack of adequate quantity and/or quality of remaining bone, infection and generalized diseases may be potential causes for failure of osseointegration both immediately after surgery, or after osseointegration is initially achieved.

After surgery:

To secure the long term treatment outcome it is advised to provide comprehensive regular patient follow up after implant treatment and to inform about appropriate oral hygiene.

Special instructions when placing NobelActive® implants:

Full seating of implant:

The unique thread design of NobelActive® implants allows to redirect the implant during insertion. This feature requires special attention to execute during placement, as the implant will not necessarily stop at the bottom of the prepared site, but may go deeper into the bone.

Insertion speed of implant:

The thread pitch allows the implant to be inserted up to four times faster compared to other implants. This means that significantly less turns are required to fully seat the implant.

Implant tightening:

If a Surgical Driver is used to insert the implant, special care needs to be taken to avoid overtightening.

Special instructions when placing NobelActive® 3.0 implants:

Indications:

NobelActive® 3.0 implants are only intended to be used for replacement of a lateral incisor in the maxilla; lateral and/or central incisor in the mandible. NobelActive® 3.0 implants are indicated only for single unit restorations.

Insertion torque for NobelActive® 3.0:

Due to the narrow implant diameter and narrow implant abutment connection the maximum insertion torque for NobelActive® 3.0 differs from the entire NobelActive® assortment. The maximum insertion tightening torque for the 3.0 implant is **45 Ncm** and the maximum prosthetic abutment tightening torque is **15 Ncm**.

Caution: Never exceed insertion tightening torque of **45 Ncm** for the implant and **15 Ncm** prosthetic tightening torque for the abutment screw. Overtightening of implant may lead to damage of the implant, fracture or necrosis of the bone site. Overtightening of the abutment screw may lead to screw fracture.

Surgical procedure:

1. During drilling procedures bone quality should be considered (please see table 1: recommended drill sequences based on bone quality to ensure optimal primary stability when applying immediate function).

1 Recommended drill sequences based on bone quality. Drill data are stated in mm and the drill diameters listed within brackets denote widening of cortex only.

Implant diameter	Soft Bone Type IV	Medium Bone Type II-III	Dense Bone Type I
3.0	1.5	2.0	2.0 2.4/2.8
3.5	2.0 (2.4/2.8)	2.0 2.4/2.8 (2.8/3.2)	2.0 2.4/2.8 2.8/3.2
4.3	2.0 2.4/2.8 (2.8/3.2)	2.0 2.4/2.8 3.2/3.6	2.0 2.4/2.8 3.2/3.6 (3.8/4.2)
5.0	2.0 2.4/2.8 3.2/3.6	2.0 2.4/2.8 3.2/3.6 3.8/4.2	2.0 2.4/2.8 3.2/3.6 3.8/4.2 (4.2/4.6)
5.5	2.0 2.4/2.8 3.2/3.6 (3.8/4.2)	2.0 2.4/2.8 3.2/3.6 3.8/4.2 4.2/4.6 (4.2/5.0)	2.0 2.4/2.8 3.2/3.6 3.8/4.2 4.2/5.0 Screw Tap

Drilling must proceed at high speed (max. 2000 rpm for Twist Step Drills) under constant and profuse external irrigation by sterile saline at room temperature.

Caution: Twist Drills and Twist Step Drills extend up to 1 mm longer than the implant when seated. Allow for this additional length when drilling near vital anatomical structures (please see image A for drill reference lines).

A



Image A shows Twist Drills and Twist Step Drills 7–15mm and implant 13mm.

2. Prepare implant site (B). When using a flapless approach add-on soft tissue height to drill depth.

3. Measure the final depth of implant site for applicable implant length using depth probe with same measurements as Twist Drills and Twist Step Drills.

4. Open the implant package and pick up the implant from inner casing by applying light pressure on the implant driver and carefully turn the implant sleeve counter clockwise until implant driver is fully seated (C). NobelActive® implants are ideally installed with low speed, max 25 rpm, using drilling device or by hand using surgical driver.

B



C

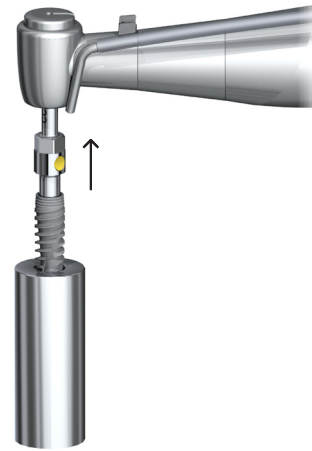

5. Place and tighten the implant. For NobelActive® 3.0 use maximum **45 Ncm** installation torque (D:1) and for NobelActive® 3.5, 4.3, 5.0 and 5.5 use maximum **70 Ncm** installation torque (D:2).

D:1

NobelActive® 3.0



D:2

NobelActive® 3.5, 4.3, 5.0, 5.5



Caution: Never exceed insertion torque of **45 Ncm** for a NobelActive® 3.0 implant and **70 Ncm** for NobelActive® 3.5, 4.3, 5.0 and 5.5 implants. Overtightening an implant may lead to damage of the implant, fracture or necrosis of the bone site. If a Surgical Driver is used to insert the implant, special care needs to be taken to avoid over tightening.

Dense bone instructions:

If the implant gets stuck during implant installation or **45 Ncm** (NobelActive® 3.0) or **70 Ncm** (NobelActive® 3.5, 4.3, 5.0, and 5.5) is achieved before fully seated:

a) rotate the implant counter clockwise approximately ½ turn enabling use of self-tapping capacity of the implant or

b) back out implant and widen the site with a wider drill according to drill protocol or

c) select a NobelActive® Screw tap matching the diameter of the implant. Drill depth for screw tap (E:1 for 3.0, 3.5 and 4.3. E:2 and E:3 for 5.5)

E:1



E:2



E:3

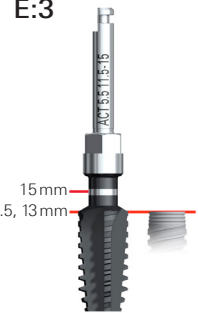

– Place screw tap into prepared implant site using low speed (25 rpm).
– Apply firm pressure and begin rotating the screw tap slowly. When the threads engage, allow screw tap to feed without pressure to defined depth.
– Switch the drill device with handpiece to reverse mode and back the screw tap out.

Continue with implant installation until desired position is achieved using max **45 Ncm** installation torque for NobelActive® 3.0 implant or max **70 Ncm** for NobelActive® 3.5, 4.3, 5.0 and 5.5 implants.

Caution: Never exceed insertion torque of **45 Ncm** for a NobelActive® 3.0 implant and **70 Ncm** for NobelActive® 3.5, 4.3, 5.0 and 5.5 implants.

To ensure ideal prosthetic abutment orientation for internal conical connection implants position one of the internal hexagon flat surfaces in the implant towards buccal/facial. To facilitate proper orientation see markings on implant drivers. (D:1 and D:2)

6. For Immediate Function, the implant should be able to withstand a final torque of **35–45 Ncm** for NobelActive® 3.0 implant and **35–70 Ncm** for NobelActive® 3.5, 4.3, 5.0, and 5.5 implants.

7. Depending on surgical protocol of choice, place a cover screw or abutment and suture (F).

F:1

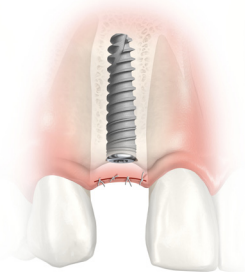



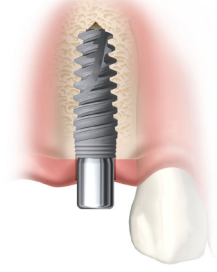

F:2



See table 2 for implant specifications.

2 Implant data

Platform	Platform diameter	Implant diameter	Abutment interface	Lengths
	3.0mm	3.0mm	2.5mm	10mm, 11.5mm, 13mm, 15mm
	3.5mm	3.5mm	3.0mm	8.5mm, 10mm, 11.5mm, 13mm, 15mm, 18mm
	3.9mm	4.3mm 5.0mm	3.4mm 3.4mm	8.5mm, 10mm, 11.5mm, 13mm, 15mm, 18mm 8.5mm, 10mm, 11.5mm, 13mm, 15mm, 18mm
	5.1mm	5.5mm	4.4mm	7mm, 8.5mm, 10mm, 11.5mm, 13mm, 15mm

For additional information on surgical procedures please consult the NobelActive® “Procedures & products” treatment guidelines available at www.nobelbiocare.com or request latest printed version from a Nobel Biocare representative.

Materials:

NobelActive® implant: commercially pure titanium grade 4.

Cover Screw: titanium alloy Ti-6Al-4V (titanium, aluminum, vanadium).

Twist Drills, Twist Step Drill and Screw Taps: stainless steel, DLC (Diamond Like Carbon) coating.

Cleaning and sterilization instructions:

NobelActive® Implants, Twist Drills and Twist Step Drills are delivered sterile for single use only prior to the labeled expiration date.

Warning: Do not use device if the packaging has been damaged or previously opened.

Caution: Implants, Twist Drills and Twist Step Drills are single use product and must not be reprocessed. Reprocessing could cause loss of mechanical, chemical and/or biological characteristics. Reuse could cause cross contamination.

NobelActive® Screw Taps are delivered sterile but indicated for multiple use. Screw Taps needs to be cleaned and sterilized before re-use.

For USA: Seal single device in a pouch and steam sterilize at 270°F–279°F (132°C–137°C) for 3 minutes.

For outside USA: Seal single device in a pouch and steam sterilize at 132°C–135°C, max. 137°C (270°F–275°F, max. 279°F) for 3 minutes.

Alternative UK: Seal single device in a pouch and steam sterilize at 134°C–135°C, max. 137°C (273°F–275°F, max. 279°F) for 3 minutes.

Full set of recommended parameters are provided in “Cleaning & Sterilization Guidelines including MRI Information of Nobel Biocare Products” available at www.nobelbiocare.com/sterilization or request latest printed version from a Nobel Biocare representative.

MR safety information:

Note: Only the NobelActive® Wide Platform implants have been assessed as MR Conditional. The other platforms and sizes have not been evaluated for safety and compatibility in the MR environment and have not been tested for heating or migration in the MR environment.

MR Conditional:

Non-clinical testing has demonstrated that product is MR Conditional. A patient with this device can be safely scanned in a MR system meeting the following conditions:

- Static magnetic field of 1.5 Tesla and 3.0 Tesla only
- Maximum spatial gradient magnetic field of 4000 Gauss/cm (40 T/m)
- Maximum MR system reported, whole body averaged specific absorption rate (SAR) of 2 W/kg (Normal Operating Mode) or 4 W/kg (First Level Controlled Mode)

Under the scan conditions defined above, the product is expected to produce a maximum temperature rise of 4.1°C after 15 minutes of continuous scanning.

In non-clinical testing, the image artifact caused by the device extends approximately 30mm from the product when imaged with a gradient echo pulse sequence and a 3.0 Tesla MRI system.

Removal restorations should be taken out prior to scanning, as is done for watches, jewelry etc.

Should there be no MR symbol on the product label, please note that the product has not been evaluated for safety and compatibility in the MR environment. The product has not been tested for heating or migration levels into account.

For additional information on Magnetic Resonance Imaging, please consult the “Cleaning & Sterilization Guidelines including MRI Information of Nobel Biocare Products” available at www.nobelbiocare.com/sterilization or request latest printed version from a Nobel Biocare representative.

Storage and handling:

The product must be stored in a dry place in the original packaging at room temperature and not exposed to direct sunlight. Incorrect storage may influence device characteristics leading to failure.

Disposal:

Disposal of the device shall follow local regulations and environmental requirements, taking different contamination levels into account.



Manufacturer: Nobel Biocare AB, Box 5190, 402 26

Västra Hamngatan 1, 411 17 Göteborg, Sweden.

Phone: +46 31 81 88 00. Fax: +46 31 16 31 52. www.nobelbiocare.com



Canada license exemption: Please note that not all products may have been licenced in accordance with Canadian law.

Prescription device: Rx only

Caution: Federal law restricts this device to sale by or on the order of a licensed physician or dentist.

Symbols Glossary:

The following symbols may be present on the device labeling or in information accompanying the device. Refer to the device labeling or accompanying information for the applicable symbols.



Authorized representative in the European Community



Batch code



Catalogue number



Caution



CE marking



Consult instructions for use



Contains hazardous substances



Contains or presence of phthalate



Date



Date of manufacture



Do not resterilize



Do not re-use



Do not use if package is damaged



Double sterile barrier system

Rx Only

For prescription use only



Health care centre or doctor



Keep away from sunlight



Keep dry



symbol.glossary.nobelbiocare.com
ifu.nobelbiocare.com

Link to Online Symbols Glossary and IFU Portal



Magnetic resonance conditional



Manufacturer



Medical device



Non-pyrogenic



Non-sterile



Patient identification



Patient information website



Patient number



Serial number



Single sterile barrier system



Single sterile barrier system with protective packaging inside



Single sterile barrier system with protective packaging outside



Sterilized using ethylene oxide



Sterilized using irradiation



Temperature limit



Tooth number



Upper limit of temperature



Sterilized using steam or dry heat



Unique Device Identifier



Use-by date

US All rights reserved.

Nobel Biocare, the Nobel Biocare logotype and all other trademarks used in this document are, if nothing else is stated or is evident from the context in a certain case, trademarks of Nobel Biocare. Product images in this folder are not necessarily to scale. All product images are for illustration purposes only and may not be an exact representation of the product.